

LINEA'TOUCH - DECOWOOD & ANODISED TRILOBED HANDRAILS - 40 MM WIDTH

BACTERICIDAL JOINT

APPLICATIONS

With a wood effect or satin silver anodised aluminium finish, the Linea'Touch handrails combine design, ergonomics and elegance. Their exclusive trilobed shape, validated by ergonomists, provides an excellent grip discreetly.

Thanks to their large choice of accessories, they fit into all insides of buildings open to the public with light traffic: corridors and staircases in retirement homes, schools, hotels, apartment blocks, public buildings, offices.

They can be bent and provide various technical solutions for continuity in staircases and in front of service ducts.

They are fitted with bactericidal joints.

SPECIFICATION

- Description: trilobed wood effect handrail (Linea'Touch - Decowood as manufactured by SPM) or satin silver anodised aluminium handrail (Linea'Touch - Anodised as manufactured by SPM) with a cross section from 28 to 40 mm to give it an ergonomic and anti-rotation design. It is 42 mm high, 40 mm width and projects 80 mm from the wall (or 90 mm on request). It consists of a 2 mm thick aluminium profile covered with a wood decor PVC film (Decowood) or 10 micron satin silver anodised (Anodised) and a closer underneath. The section comprises a groove into which brackets and closer slide and lock. Wall fixing is by silver anodised effect aluminium brackets with 2-point self-locking: 20 mm wide refined bracket or 55 mm wide bugled bracket. Wall fixing is also available by swan-neck with 70 mm rose brackets, in brushed stainless steel, 3 point self-locking. The axial position of the brackets provides an excellent guiding. Various smooth and antibacterial PVC accessories with solid colour (flat or beveled endcaps, classic or extended and curved wall returns, 90° internal/external angle or made-to-measure from 90° to 160°), supplied with bactericidal joints, are available in anodised look to finish the handrail assembly and are sleeved into the profile with clamping screws. All technical solutions are available to ensure continuity around corners (90° or made-to-measure), in staircases (3-way "universal joint" rotation angle - Rapid'Angle® as manufactured by SPM), across service ducts (quick removable assembly wedge) and around curved sections (pre-curved in the factory). These handrails achieve an impact resistance in excess of 70 Joules, i.e., an impact of more than 220 kg travelling at 2 km/h.
- Environment: no heavy metals and no substance potentially subjected to any REACH restriction are used in its manufacture, nor PBT/ BPA. The calcium-zinc thermal stabilisation process is used. The emission level of volatile substance in inside air has been tested according to ISO 16000-6 and is very low (A+) according to the French regulation (23 March 2011 nr 2011-321 Decree and 19 April 2011 Order). 100% of the product are recyclable.
- Colour: selected by architects from manufacturer's standard range.
- Installation method: upper edge of section 0.90 m max. above level. Fixes to 2-point or 3-point self-locking brackets, depending on the model, screwed to the wall at 1.20 m centres (0.80 m centres in heavy traffic corridors and on light partitions like plasterboard). Wall returns, endcaps and angles to be fixed with 2.5 mm Allen clamping screws.

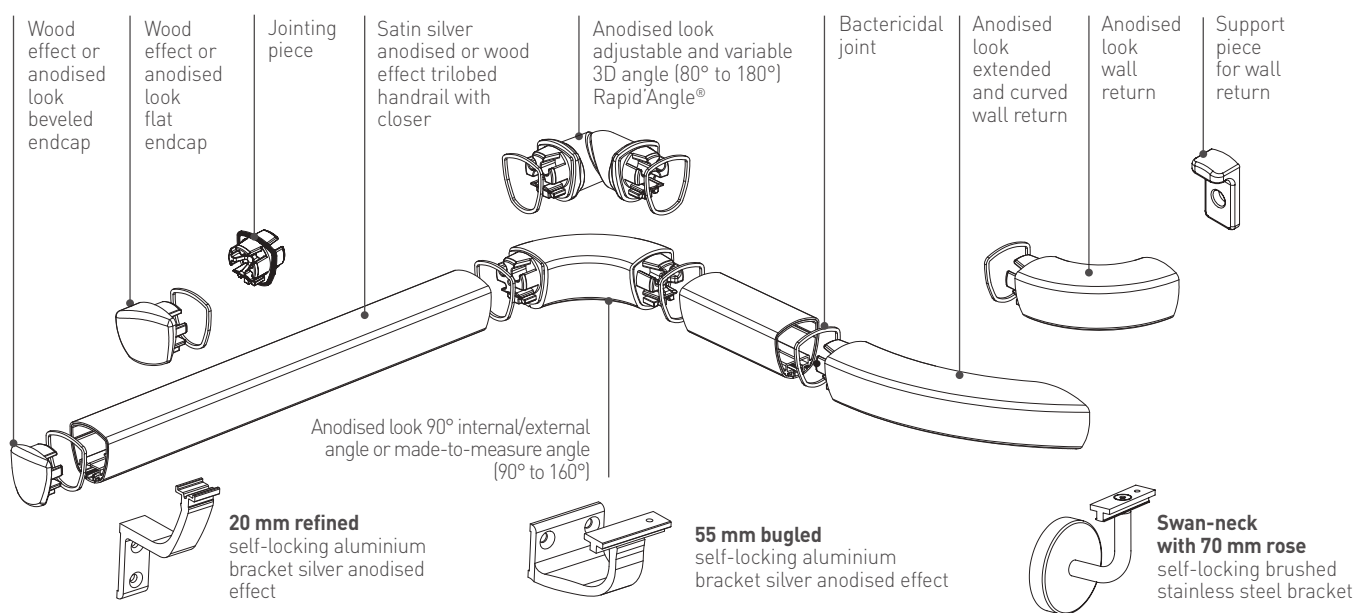



Available in
LED option

Linea'Touch - Decowood
| 6 wood decors

Linea'Touch
Anodised



Colours available per product: please see the colour summary hinge



DESCRIPTION

- Model: Linea'Touch - Decowood or Anodised - trilobed handrail
- Cross section: height 42 mm x width 40 mm
- Length: 4 m
- Overall projection: 80 mm (90 mm on request)
- Stand-off from wall: 40 mm (50 mm on request)
- Material: 10 micron satin silver anodised aluminium or wood effect PVC, bactericidal joint
- Fixing: on self-locking brackets
 - refined, bugled or reinforced, 2-point fixing in aluminium, silver anodised effect
 - swan-neck with 70 mm rose, 3 point fixing in brushed stainless steel screwed to the wall every 1.20 m (0.80 m centres in heavy traffic areas and on light partitions like plasterboard)
- Colours:
 - 6 wood decors for Linea'Touch - Decowood
 - satin silver anodised for Linea'Touch - Anodised

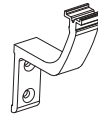

20 mm refined
self-locking aluminium bracket
silver anodised effect
(overall projection 80 mm)

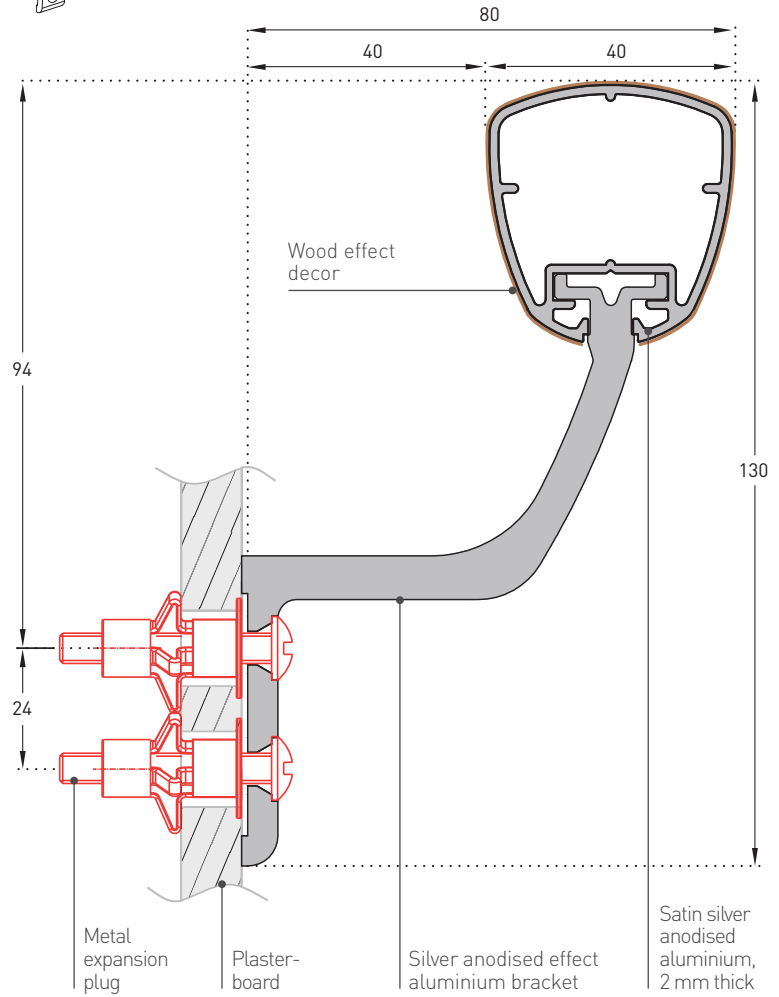

LINEA'TOUCH DECOWOOD

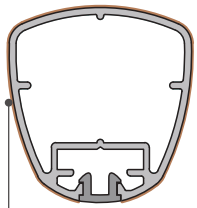

Wood decor

LINEA'TOUCH ANODISED

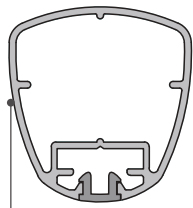

Satin silver anodised
aluminium

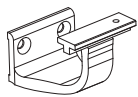

55 mm bugled
self-locking aluminium bracket
silver anodised effect
(overall projection 80 mm)

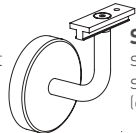

Swan-neck with 70 mm rose
self-locking brushed
stainless steel bracket
(overall projection 80 mm)

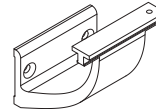

80 mm reinforced
self-locking
aluminium bracket
silver anodised effect
(overall projection 90 mm)

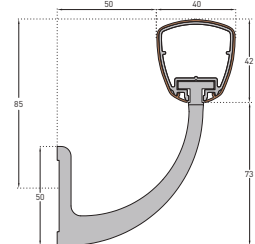
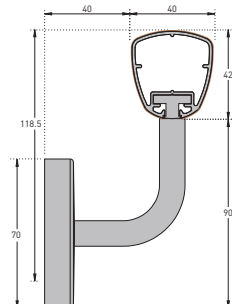
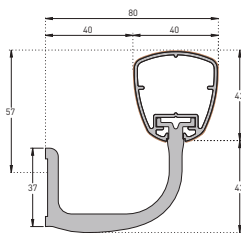

Specifications and section drawings on our website www.spm-international.com



bimobject

BimObject in Revit and Archicad